

PRODUCT DESCRIPTION

- Will accommodate LEDs up to 14.6 mm wide
- Possible to obtain a watertight lighting fixture

Fill empty fields

| | |
|--------------|--|
| Product nr. | |
| Fixture type | |
| Company | |
| Job name | |
| Date | |



TECHNICAL SPECIFICATION

| | | |
|--------------|-----------------|---------|
| B9325ANODA_1 | Silver anodized | 39.4" |
| B9325ANODA_2 | Silver anodized | 78.75" |
| B9325ANODA_3 | Silver anodized | 118.11" |

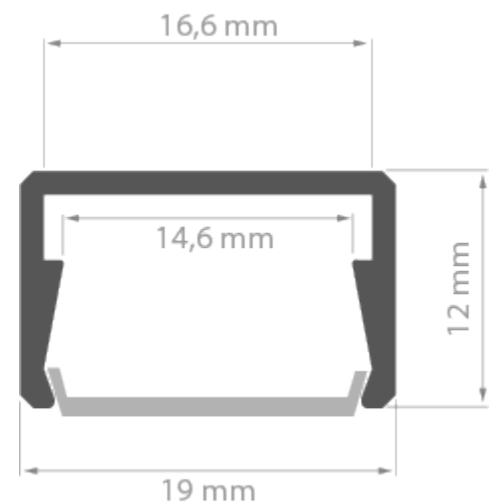

RELATED PRODUCTS

COVERS

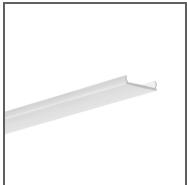

Ref: 17039

90°



END CAPS



Ref: 24236

ACCESSORIES



Ref: 24144



Ref: 42212



Ref: 00652



Ref: 42210



Ref: 42215

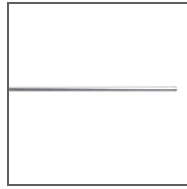

Ref: 42101

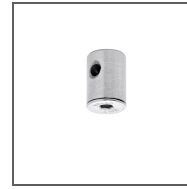

Ref: 42213



Ref: 00651

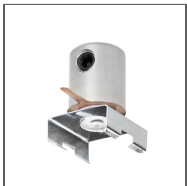

Ref: 00654



Ref: 1455

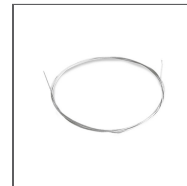

Ref: 70240

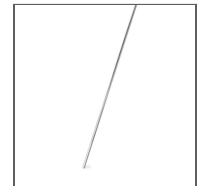

Ref: 42501

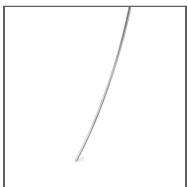

Ref: 1528

COUPLERS - connection methods for profiles



L135

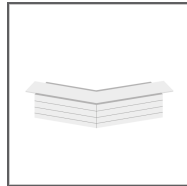

L135PW

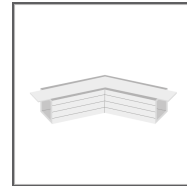

L135PZ

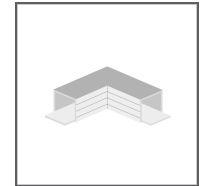

L90

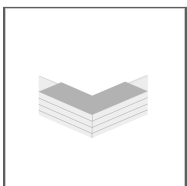

L90PW

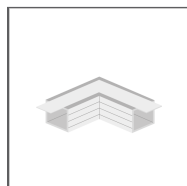

L90PZ

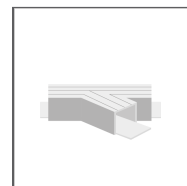

T135L

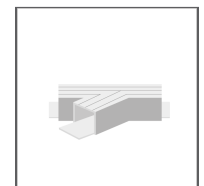

T135R

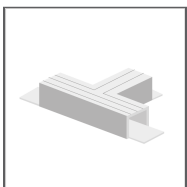

T90

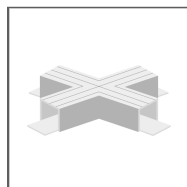

X135

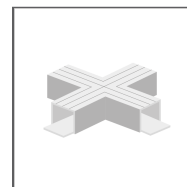

X90