

**PRODUCT DESCRIPTION**

SEPOD - a basic extrusion used to build suspended or surface mounted fixtures. To build suspended fixtures you can use DP fasteners, drywall fasteners or ready-made KLUŚ fastening kits. To surface mount the SEPOD extrusion you can use GP surface springs, KMA groove springs or the TESPO mounting track.

Patent Number: US D775,409 S

- High luminous efficiency
- Ability to create a line of light
- Easy mounting with numerous methods
- Can be combined into straight and broken linear runs

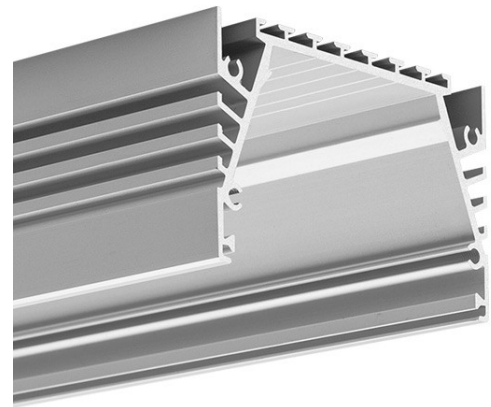

Fill empty fields

Product nr.	
Fixture type	
Company	
Job name	
Date	

**TECHNICAL SPECIFICATION**

18018ANODA_1	Silver anodized	39.4"
18018ANODA_2	Silver anodized	78.75"

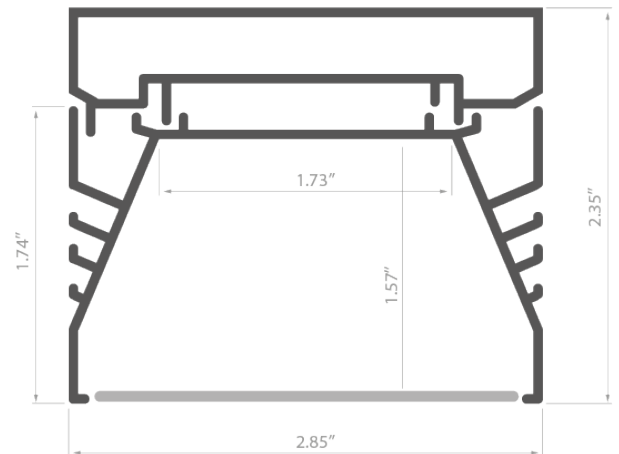



## RELATED EXTRUSIONS

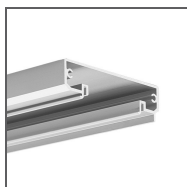

Ref: 18020

## RELATED PRODUCTS

### COVERS

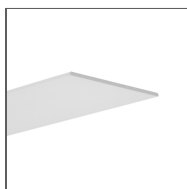

Ref: 17082

80°

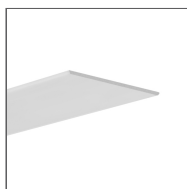

Ref: 17081

80°

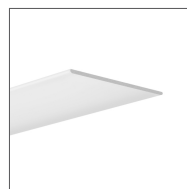

Ref: 17083

110°



### END CAPS

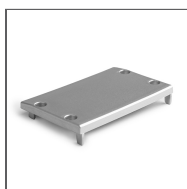

Ref: 24106

ACCESSORIES



Ref: 42717

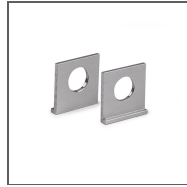

Ref: 42512

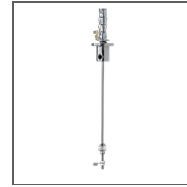

Ref: 42614



Ref: 42719



Ref: 42718

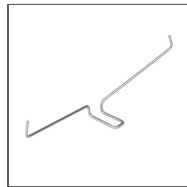

Ref: 00293

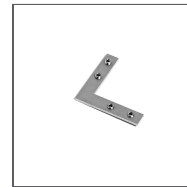

Ref: 42716



Ref: 42728

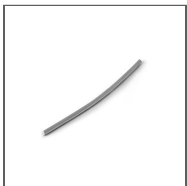

Ref: 42731V1

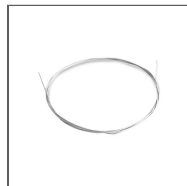

Ref: 70240

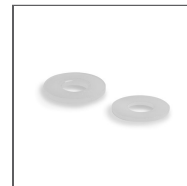

Ref: 42203



Ref: 42256



Ref: 42204

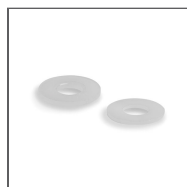

Ref: 42205



Ref: 42250

**COUPLERS** - connection methods for profiles



L135

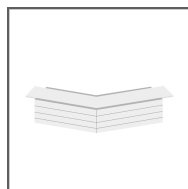

L135PW



L135PZ

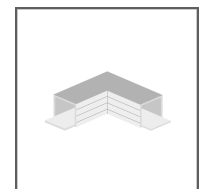

L90

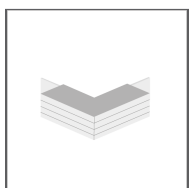

L90PW

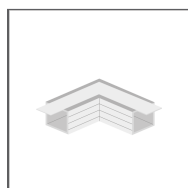

L90PZ

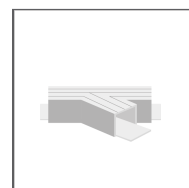

T135L

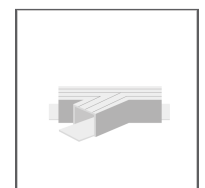

T135R

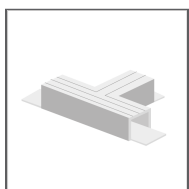

T90

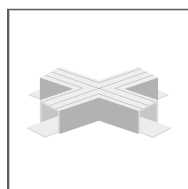

X135

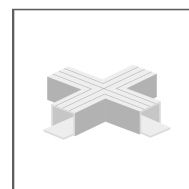

X90