

PRODUCT DESCRIPTION

Patent Number: US D698,075 S

- A movable insert for LEDs enabling four different lighting angles
- Four beam angles: 10, 30, 60 and 90 degrees
- Housing for flexible or hard LED strips that are 8-10mm wide (0.4")



Fill empty fields

Product nr.	
Fixture type	
Company	
Job name	
Date	

TECHNICAL SPECIFICATION

B468+43ANODA_1	Silver anodized	39.4"
B468+43ANODA_2	Silver anodized	78.75"
B468+43ANODA_3	Silver anodized	118.11"

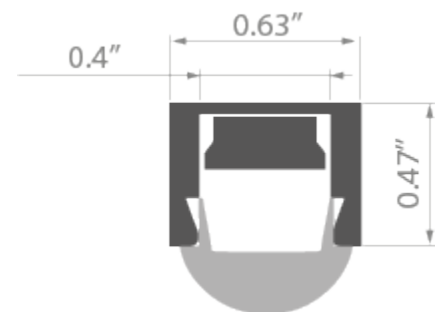

RELATED PRODUCTS

COVERS



Ref: 17111

90°



Ref: 17072

90°

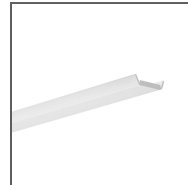

Ref: 1369

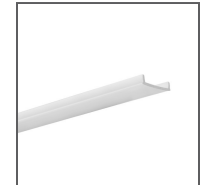

Ref: 17071

90°



END CAPS



Ref: 00313



Ref: 1407



Ref: 00310

ACCESSORIES



Ref: 42216

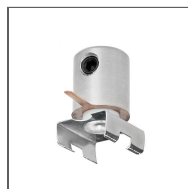

Ref: 00647



Ref: 24190



Ref: 42218

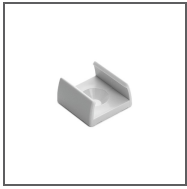

Ref: 24041

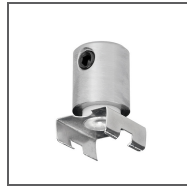

Ref: 00645

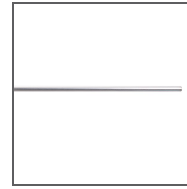

Ref: 42101



Ref: 42215



Ref: 42213



Ref: 00651

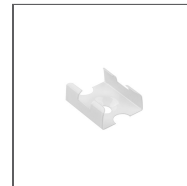

Ref: 24223



Ref: 24189

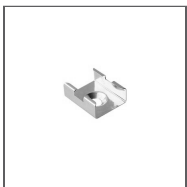

Ref: 1345

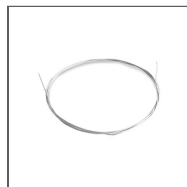

Ref: 70240

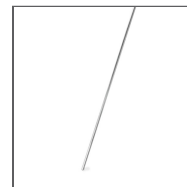

Ref: 42501

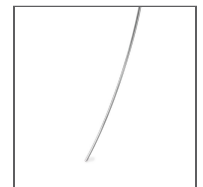

Ref: 1528

COUPLERS - connection methods for profiles



L135

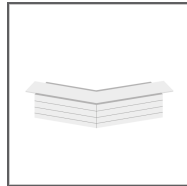

L135PW

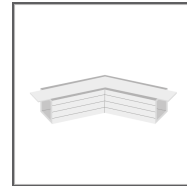

L135PZ

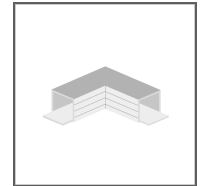

L90

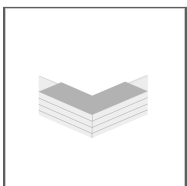

L90PW

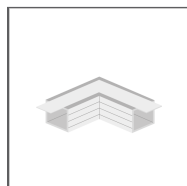

L90PZ

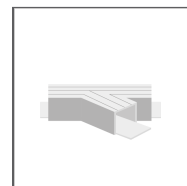

T135L

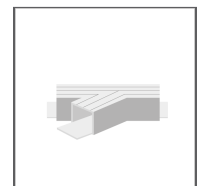

T135R

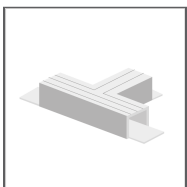

T90

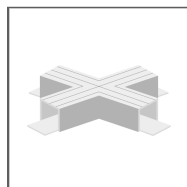

X135

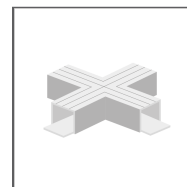

X90