

**PRODUCT DESCRIPTION**

Small dimensions (just 6 mm; 0.23" high), profile can fit slim design and thin furniture pieces, special collar of the profile enables unaesthetic grooves to be covered,  
\* (groove - a specially prepared narrow space in the wall surface, drywall, stone block etc.) easy assembly, lightweight, easily release heat, environment friendly.

Patent Number: US D623,342 S

- Recessed housing for flexible or hard LED strips that are 8-10mm wide (0.39")
- Masking the channel edge



Fill empty fields

Product nr.	
Fixture type	
Company	
Job name	
Date	

**TECHNICAL SPECIFICATION**

B3776ANODA_1	Silver anodized	39.4"
B3776ANODA_2	Silver anodized	78.75"
B3776K7_black	Black anodized	39.4"
B3776K7- Black	Black anodized	78.75"

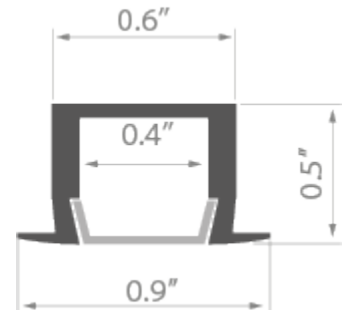

RELATED PRODUCTS

COVERS

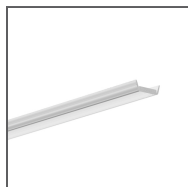

Ref: 1370

50°



Ref: 17072

90°

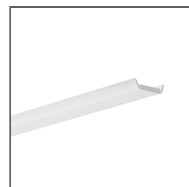

Ref: 1369

100°

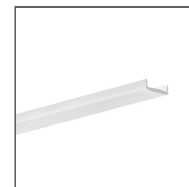

Ref: 17031

120°

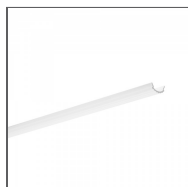

Ref: 17076

120°

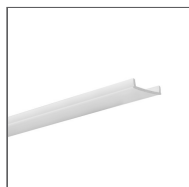

Ref: 17071

90°



END CAPS

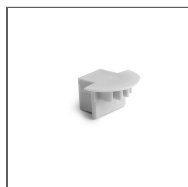

Ref: 1447

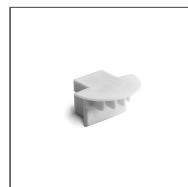

Ref: 00032

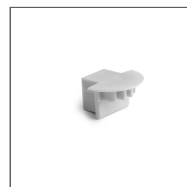

Ref: 1438

ACCESSORIES

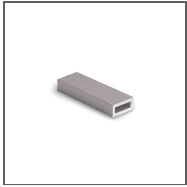

Ref: 00036



Ref: 00035

**COUPLERS** - connection methods for profiles



L135

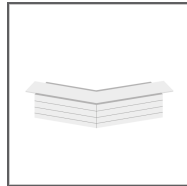

L135PW

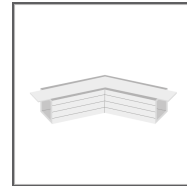

L135PZ

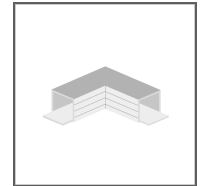

L90

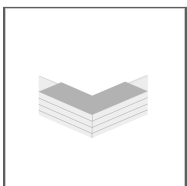

L90PW

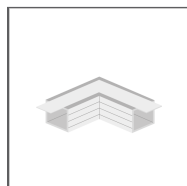

L90PZ

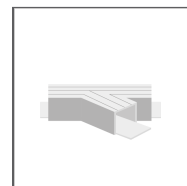

T135L

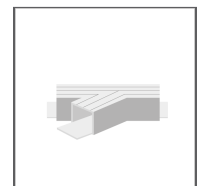

T135R

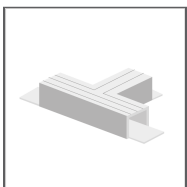

T90

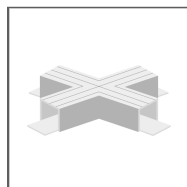

X135

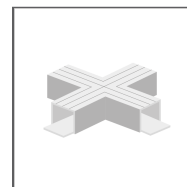

X90