

PRODUCT DESCRIPTION

Small dimensions (just 6 mm; 0.23" high), profile can fit slim design and thin furniture pieces, special collar of the profile enables unaesthetic grooves to be covered,
* (groove - a specially prepared narrow space in the wall surface, drywall, stone block etc.) easy assembly, lightweight, easily release heat, environment friendly.

Patent Number: US D623,343 S

- Recessed shallow housing for flexible or hard LED strips that are 8-10mm wide (0.39")
- Masks the edges of the groove
- Small size



Fill empty fields

Product nr.	
Fixture type	
Company	
Job name	
Date	

TECHNICAL SPECIFICATION

B3775ANODA_1	Silver anodized	39.4"
B3775ANODA_2	Silver anodized	78.75"

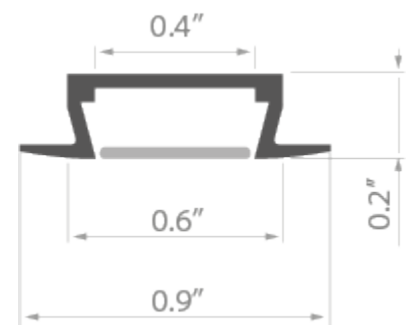

RELATED PRODUCTS

COVERS

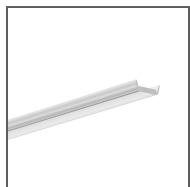

Ref: 1370

90°



Ref: 17072

90°

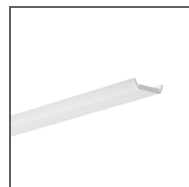

Ref: 1369

110°

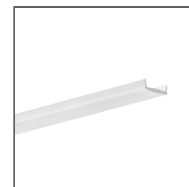

Ref: 17031

120°

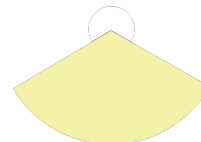

Ref: 17071

90°



END CAPS

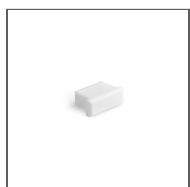

Ref: 20004

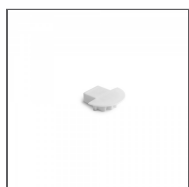

Ref: 21004

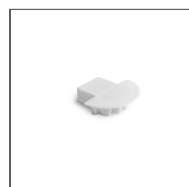

Ref: 00025



Ref: 23004



Ref: 1448



Ref: 1430

ACCESSORIES



Ref: 00036



Ref: 00035

COUPLERS - connection methods for profiles



L135

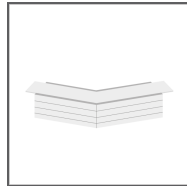

L135PW

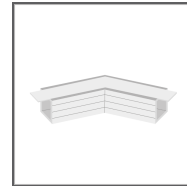

L135PZ

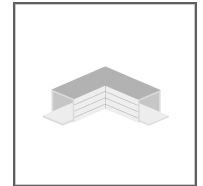

L90

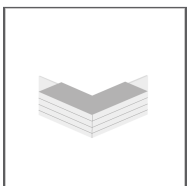

L90PW

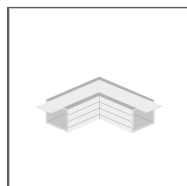

L90PZ

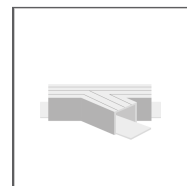

T135L

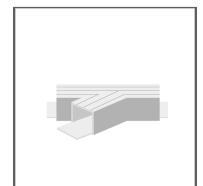

T135R

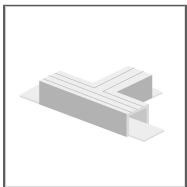

T90

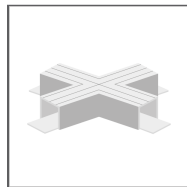

X135

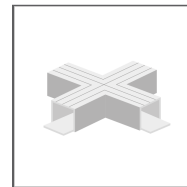

X90